

Silicon PNP Power Transistors

2SA1302

**DESCRIPTION**

- With TO-3PL package
- Complement to type 2SC3281

**APPLICATIONS**

- Power amplifier applications
- Recommended for 100W high fidelity audio frequency amplifier output stage

**PINNING**

PIN	DESCRIPTION
1	Emitter
2	Collector;connected to mounting base
3	Base

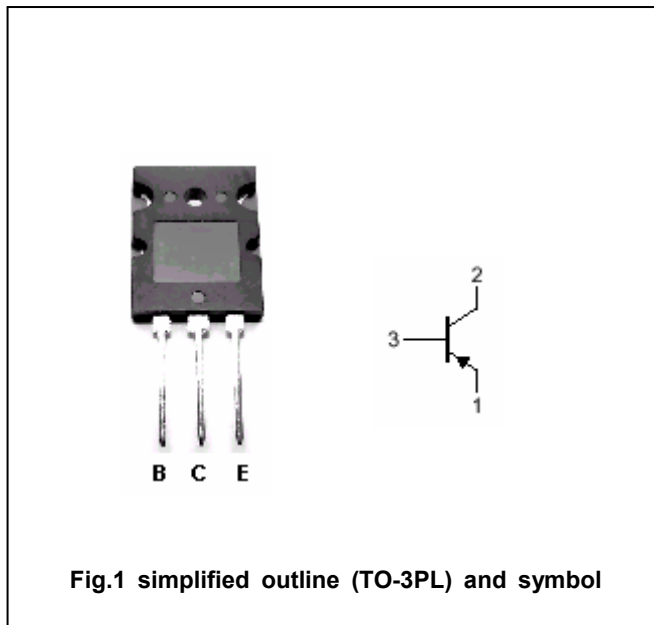

**Absolute maximum ratings(Ta=25°C)**

SYMBOL	PARAMETER	CONDITIONS	VALUE	UNIT
V <sub>CB0</sub>	Collector-base voltage	Open emitter	-200	V
V <sub>CEO</sub>	Collector-emitter voltage	Open base	-200	V
V <sub>EBO</sub>	Emitter-base voltage	Open collector	-5	V
I <sub>C</sub>	Collector current		-15	A
I <sub>B</sub>	Base current		-1.5	A
P <sub>C</sub>	Collector power dissipation	T <sub>C</sub> =25°C	150	W
T <sub>j</sub>	Junction temperature		150	°C
T <sub>stg</sub>	Storage temperature		-55~150	°C

## Silicon PNP Power Transistors

## 2SA1302

## CHARACTERISTICS

T<sub>j</sub>=25°C unless otherwise specified

SYMBOL	PARAMETER	CONDITIONS	MIN	TYP.	MAX	UNIT
V <sub>(BR)CEO</sub>	Collector-emitter breakdown voltage	I <sub>C</sub> =-50mA ; I <sub>B</sub> =0	-200			V
V <sub>CEsat</sub>	Collector-emitter saturation voltage	I <sub>C</sub> =-8A; I <sub>B</sub> =-0.8A			-2.5	V
V <sub>BE</sub>	Base-emitter voltage	I <sub>C</sub> =-8A ; V <sub>CE</sub> =-5V			-1.5	V
I <sub>CBO</sub>	Collector cut-off current	V <sub>CB</sub> =-200V; I <sub>E</sub> =0			-5	μA
I <sub>EBO</sub>	Emitter cut-off current	V <sub>EB</sub> =-5V; I <sub>C</sub> =0			-5	μA
h <sub>FE-1</sub>	DC current gain	I <sub>C</sub> =-1A ; V <sub>CE</sub> =-5V	55		160	
h <sub>FE-2</sub>	DC current gain	I <sub>C</sub> =-8A ; V <sub>CE</sub> =-5V	35			
f <sub>T</sub>	Transition frequency	I <sub>C</sub> =-1A ; V <sub>CE</sub> =-5V		25		MHz
C <sub>OB</sub>	Collector output capacitance	I <sub>E</sub> =0;f=1MHz;V <sub>CB</sub> =-10V		470		pF

◆ h<sub>FE-1</sub> classifications

R	O
55-110	80-160

Silicon PNP Power Transistors

2SA1302

PACKAGE OUTLINE

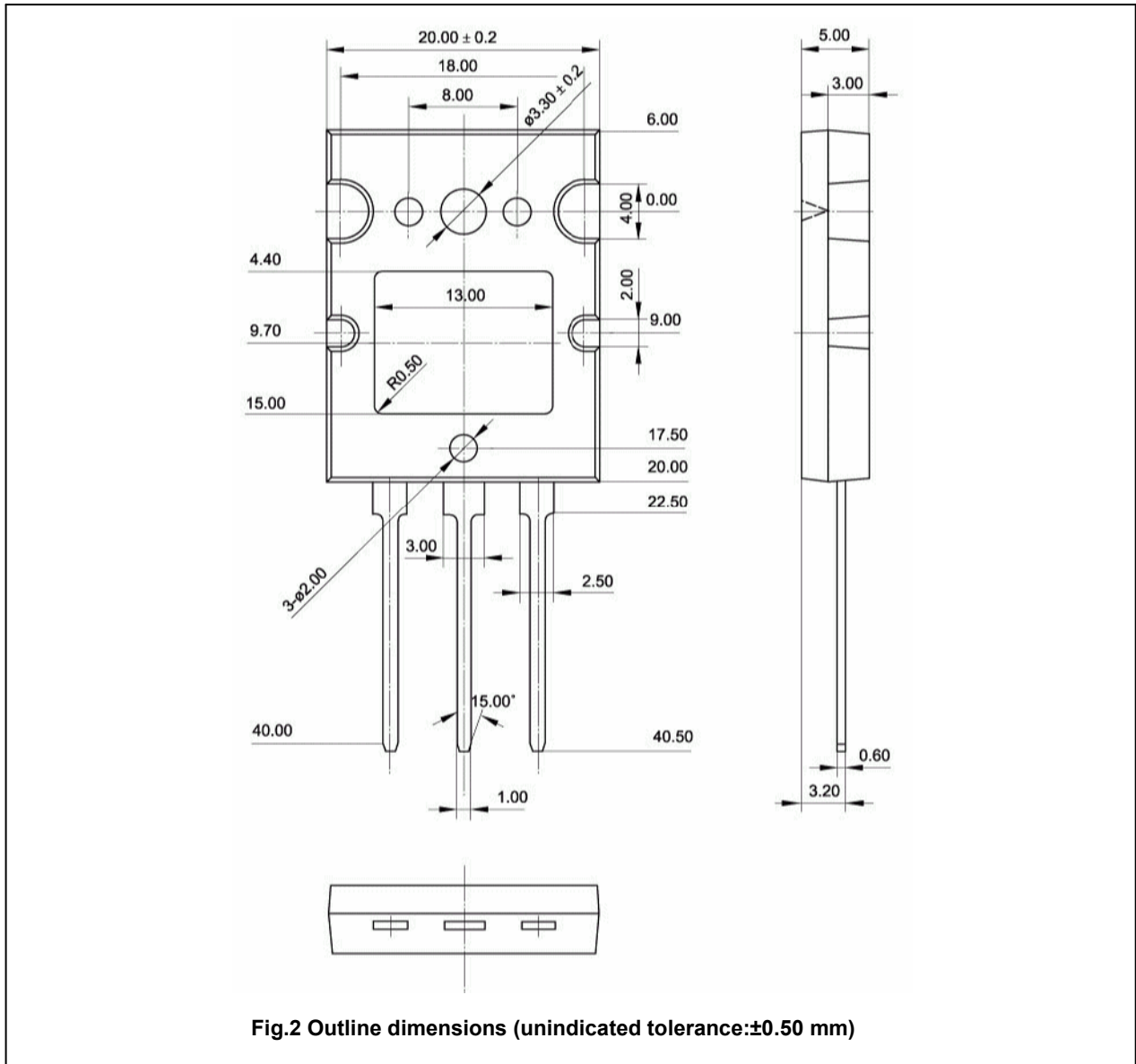

Silicon PNP Power Transistors

2SA1302

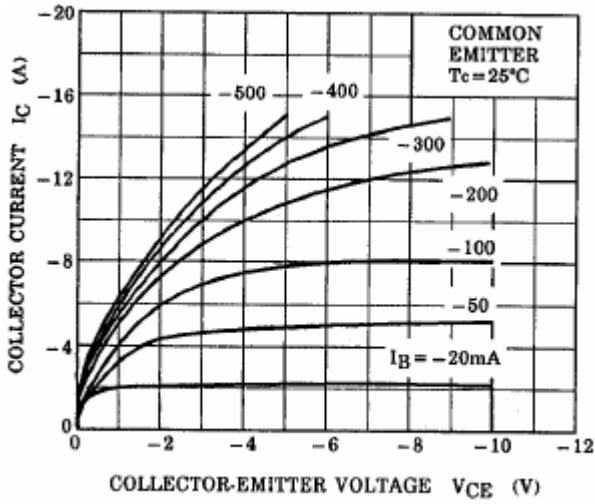

Fig.3 Static Characteristic

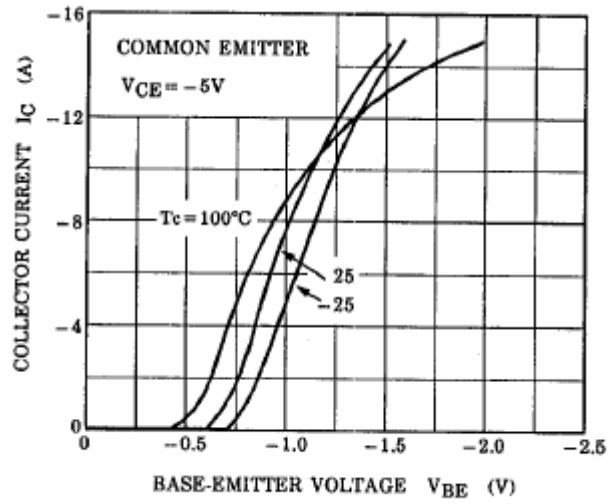

Fig.3 Base-Emitter On Voltage

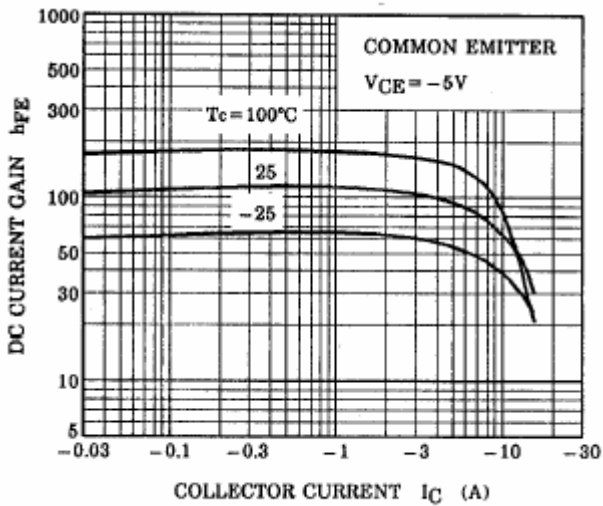

Fig.5 DC current Gain

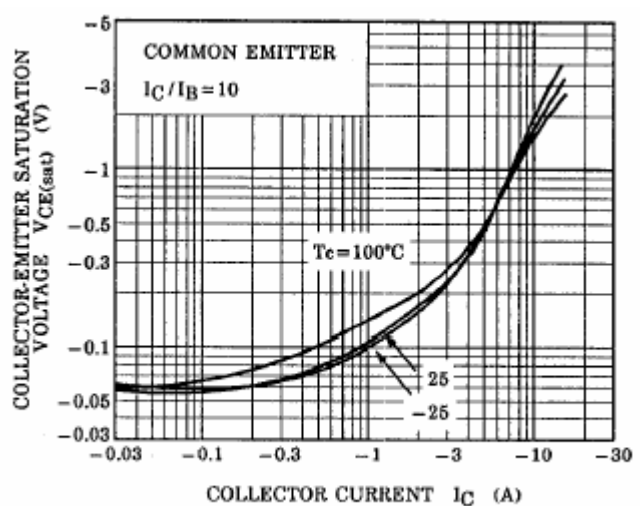

Fig.6 Collector-Emitter Saturation Voltage

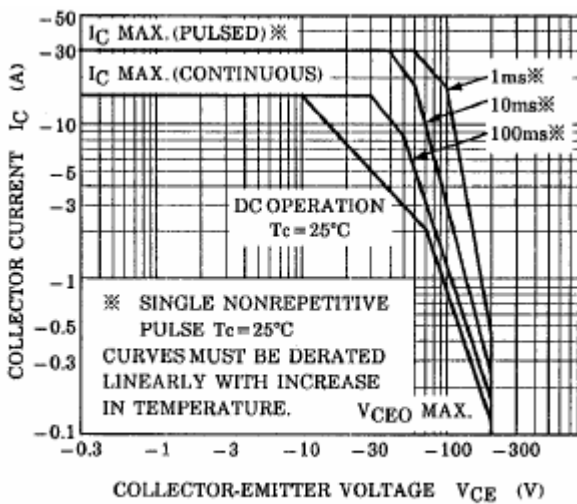

Fig.7 Safe Operating Area